

Make the right move with
PLATINUM.



www.cabp.es

Salvaescaleras

For every kind of staircase, worldwide

Straight stairs

The Platinum Horizon

The complete straight stairlift.

Standard Product Features:

- Revolutionary Ergo chair
- Powered swivel
- Manual lever linked footrest
- Adjustable seat to footrest height
- Adjustable sideways footrest
- Maximum user weight limit 140kg
- Anodised Aluminium single rail
- Rail angles - 25° to 62°
- Digital diagnostic display in arm
- Infra-red remote controls
- Retractable reel seat belt.

Platinum has the solution.



Platinum,
the unique stairlift,
sold throughout
the world.

**Curved
stairs**

The Platinum Curve

Hand-built perfection.

Standard Product Features:

- Twin tube steel rail
- Quiet and smooth ride quality
- Tight internal bend on a 200mm radius
- Fits tight to the staircase
- Revolutionary Ergo chair
- Digital diagnostic display in arm
- Retractable reel seat belt
- Quickest lead times in industry.

Product Options:

- Powered Swivel and Footrest options
- Lever Linked Footplate option
- Footcover option
- Heavy Duty Option available up to 160kg.

Argentina
Australia
Austria
Belgium
Brazil
Canada
China
Croatia
Cyprus
Denmark
England
Finland
France
Germany
Greece
Holland
India
Ireland
Israel
Italy
Latvia
Luxembourg
Malaysia
Malta
New Zealand
Northern Ireland
Norway
Oman
Phillippines
Poland
Portugal
Saudi Arabia
Scotland
South Africa
Spain
Sweden
Switzerland
Turkey
Uruguay
USA
Wales

Using a Platinum stairlift is very simple.



Unfold the arms and the seat pad, put the footplate down and your stairlift is ready to use. The digital diagnostic display will display 'Platinum'.

1

2

Sit on the revolutionary Ergo chair that can be fully adjusted to ensure the perfect fit for you at installation.

**3**

To operate the stairlift simply use the ergonomic joystick in the end of the arm by lightly pressing the joystick in the direction you wish to travel.

**4**

At the top you can swivel the chair onto the landing to allow safe transfer on and off the stairlift.

**5**

When not in use the stairlift can be parked away on the stairs to leave space for other family members.



Discover the unique features.



Ergonomic joystick

Can be used as a button or lever to make the stairlift easy to operate in a natural and comfortable position even with limited mobility.

Unique
worldwide

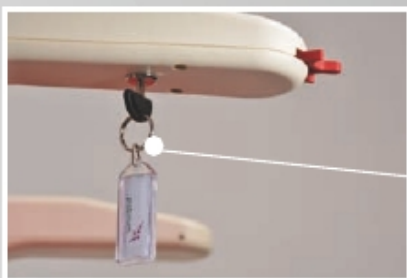

Security key switch

under the armrest, to prevent unauthorized use of your stairlift.

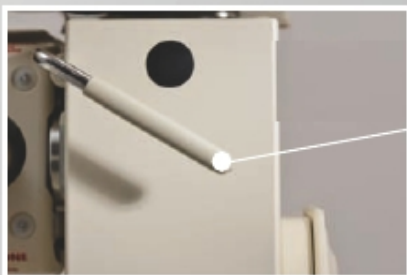

Independent lever linked footrest raiser

to open and close the footrest easily when you need it without having to bend down (powered option also available). Also allows easy transfer for wheelchair users.



ERGO plus seat

designed to optimize the position of the legs when seated.

Unique
worldwide





Digital diagnostic display

built into the armrest, to check all the information and diagnostics about you stairlift in real time.

Unique
Worldwide

Retractable reel seat belt

to provide additional security to move safely.

Seat swivel lever

To turn you at the top of the stairs simply manually lift the lever up. Powered swivel option also available which works off the ergonomic joystick.

Safety edge sensitivity

These would immediately stop the stairlift in the event of any obstructions on the stairs during travel.

HD Classic seat

An option unique to the Platinum Curve designed with a user weight of up to 160 kg.

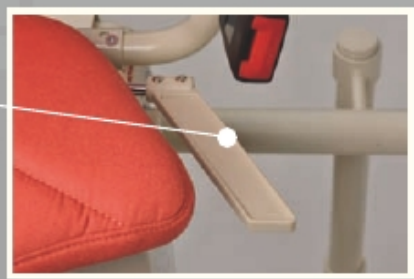
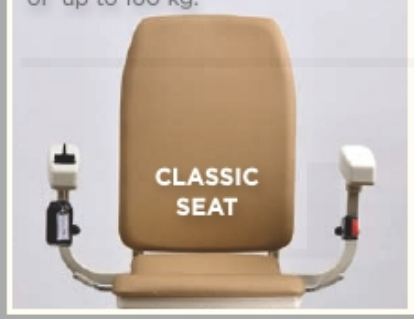

Platinum - Designed with you in mind



Open the footrest
This is easy and independent from the armrest.



Remotes controls

Two come with every stairlift, allowing you to call the stairlift to where you need it.



Automatic swivel
to rotate at the top of the stairs unaided.

and easy to use.

- Start delay to prevent accidental operation
- Choice of colours. Change the upholstery and look new in seconds.
- Battery operated so works in the event of a power cut
- User weight capacity up to 160 kg on curve and 140 kg on straight.

Upholstery colors.

Quality fabrics and tailored finishes.

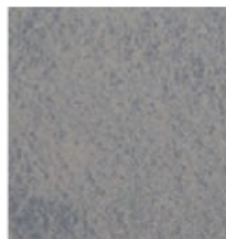

Grey Vinyl



Red Vinyl

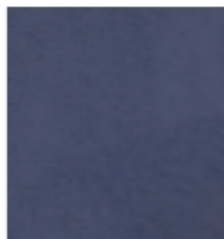

Blue Vinyl

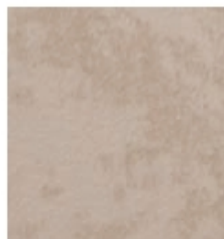

Beige Vinyl

completely safe

with a capacity
of up to 160kg.

One of the tightest
internal bends on the
market making your
Platinum achieve
the best possible
fit to your
staircase.



Curved or straight,

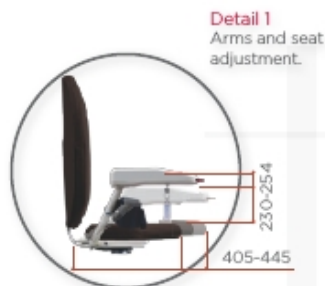
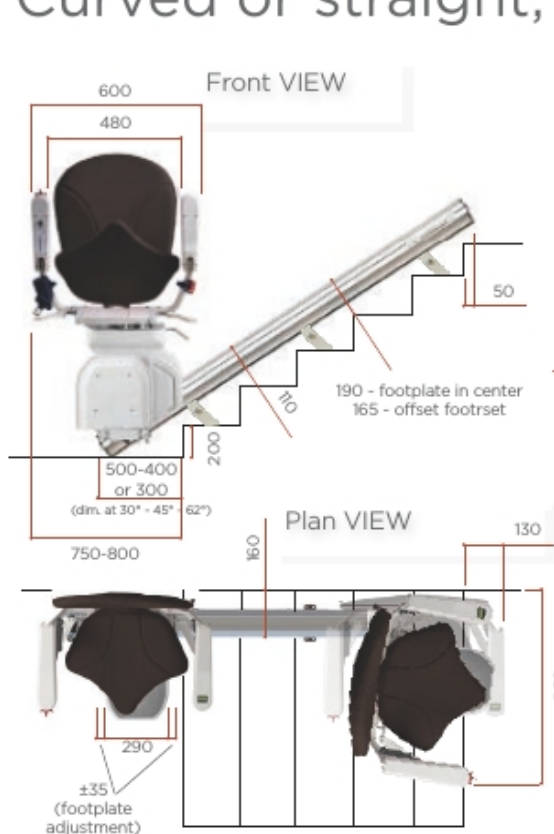

Power supply	Batteries, 2 x 12 volt, consumption 0,014 kWh
Recharge	Automatic, in the charging points
Speed	0,12 m/sec.
Wiring	Internal with charging plates at the ends of the rail
Manufacture	Aluminium single rail
Anchorage	Mounting step through telescopic brackets. Wall mounting optional.
Traction	Rack and pinion with OSG control
Diagnostic	built into armrest, internal memory and operating report
Rail slope	25 - 62° max
Engine	Battery supply, 0,26kw
Recharge	External unit, 24 volt in two stages
Warranty	24 months
Capacity	140 kg

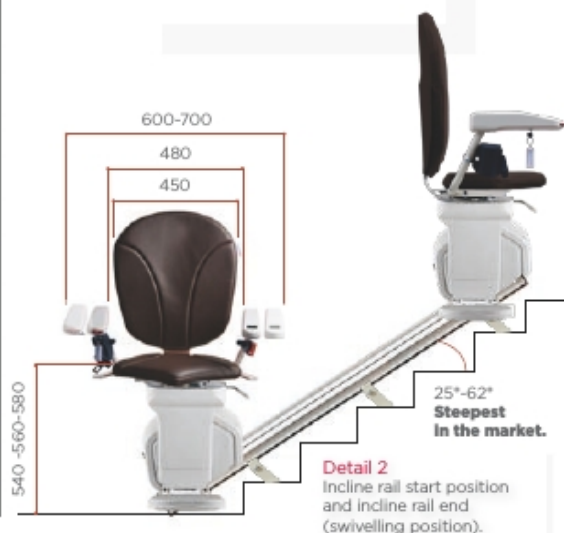

the Chair is always ERGO.

Front VIEW

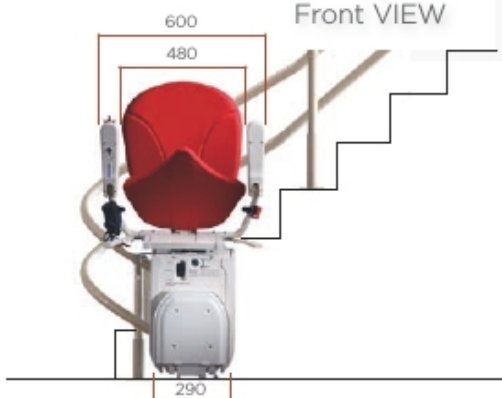

Side VIEW

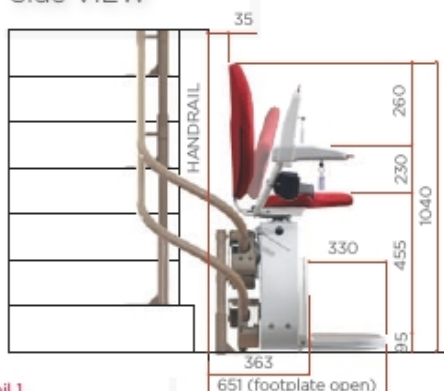

Detail 1
Armrests and seat adjustment.

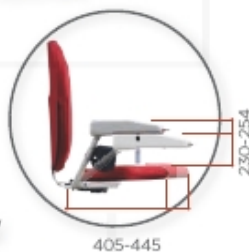

HD Classic seat available for curves: up to 160 kg.



Minimum rail intrusion for a stairlift not ERGO.

Plan VIEW

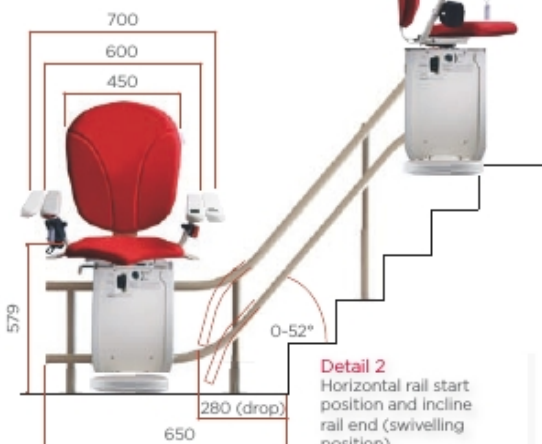
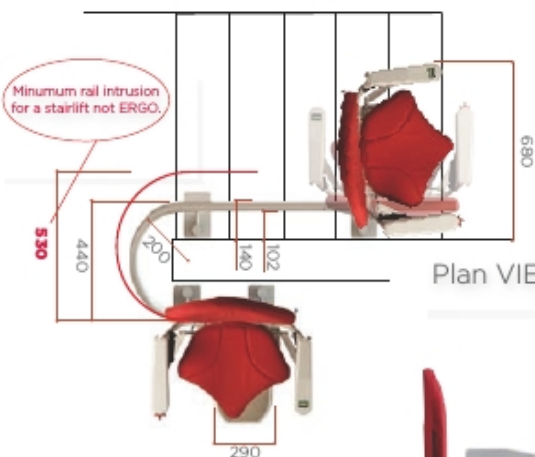

Detail 2
Horizontal rail start position and incline rail end (swivelling position).

Power supply	Batteries, 2 x 12 volt, consumption 0,014 kWh
Recharge	Automatic, in the charging points
Speed	0,12 m/sec. Electronically adjustable
Wiring	Internal with charging plates at the ends of the rail
Manufacture	2 steel tubular, 38mm diameter and bend radius 200mm
Anchorage	Mounting step through telescopic brackets. Wall mounting optional.
Traction	Rack and pinion with OS&G control
Diagnostic	built into armrest, internal memory and operating report
Rail slope	0 - 52° max
Engine	Battery supply, 0,26kw
Recharge	External unit, 24 volt in two stages
Warranty	24 months
Capacity	120 kg (160 kg available on HD model)